



INDUSTRIAL DIRECT DRIVE 14

Positive Indirect Gas Heated Air Curtain

Data Sheet

For Mounting Heights To 14' (environmental separation)

STANDARD CONSTRUCTION

- 1 hp single speed motor(s) - direct drive (Optional: two-speed)
- Gray powder coated exterior with mill aluminum screen and access panels (Optional: Custom Color or Stainless)
- Top Mounting only
- Front air intake only
- High efficiency Pro-V Nozzle

- Factory mounted duct transition with bottom access panels
- Field installed ETL (US and Canada) & AHRI Certified indirect gas heater(s):
 - Aluminized steel heat exchanger (Optional: Stainless)
 - Steel cabinet with beige finish
 - Spark ignited pilot
 - Power venter
 - Separate 120V power supply required (Optional: transformer for single point connection)

**2 Year
Limited
Warranty**



MODEL	Nozzle Width (in)	Max Vel. at Nozzle (fpm)	Avg. Outlet Vel. (fpm)	Air Volume (cfm)	Outlet Vel. Uniformity	Power Rating (kW)	Motor(s) @ hp	Heater(s) @ Input (MBH)	Total Heater Output (MBH)	Air Temp. Rise (°F)	Net Wt. Air Curtain (lbs)	Net Wt. Duct Trans. (lbs)	Net Wt. Heater (lbs)
IDC14-1036G	36.00	7,567	2,738	2,396	87%	1.12	1 @ 1	1 @ 100.0	83.0	32°	103	85	135
IDC14-1042G	42.00	7,040	2,435	2,486	81%	1.12	1 @ 1	1 @ 100.0	83.0	31°	109	92	135
IDC14-1048G	48.00	7,175	2,173	2,535	84%	1.25	1 @ 1	1 @ 100.0	83.0	30°	114	99	135
IDC14-1060G	66.00	6,886	1,620	2,598	80%	1.28	1 @ 1	1 @ 100.0	83.0	29°	125	122	135
IDC14-2060G	66.00	7,520	3,136	4,574	97%	2.07	2 @ 1	1 @ 200.0	166.0	33°	175	116	204
IDC14-2072G	72.00	7,567	2,738	4,792	87%	2.24	2 @ 1	1 @ 200.0	166.0	32°	184	123	204
IDC14-2078G	78.00	7,040	2,575	4,882	81%	2.24	2 @ 1	1 @ 200.0	166.0	31°	190	131	204
IDC14-2084G	84.00	7,040	2,435	4,972	81%	2.24	2 @ 1	1 @ 200.0	166.0	31°	195	138	204
IDC14-2096G	99.00	7,175	2,173	5,070	84%	2.50	2 @ 1	1 @ 200.0	166.0	30°	205	157	204
IDC14-3096G	99.00	7,567	2,987	6,970	87%	3.19	3 @ 1	1 @ 300.0	249.0	33°	249	167	311
IDC14-2108G	108.00	6,886	1,956	5,133	80%	2.53	2 @ 1	1 @ 200.0	166.0	30°	248	168	204
IDC14-3108G	108.00	7,567	2,738	7,188	87%	3.36	3 @ 1	1 @ 300.0	249.0	32°	292	178	311
IDC14-2120G	117.00	6,886	1,827	5,197	80%	2.56	2 @ 1	1 @ 200.0	166.0	29°	255	179	204
IDC14-3120G	117.00	7,040	2,526	7,368	81%	3.36	3 @ 1	1 @ 300.0	249.0	31°	299	189	311
IDC14-3132G	132.00	7,040	2,340	7,507	81%	3.49	3 @ 1	1 @ 350.0	290.5	36°	320	207	325
IDC14-3144G	144.00	7,175	2,173	7,605	84%	3.75	3 @ 1	1 @ 350.0	290.5	35°	334	222	325
IDC14-4144G	144.00	7,567	2,738	9,584	87%	4.48	4 @ 1	1 @ 400.0	332.0	32°	378	222	339
IDC14-4156G	156.00	7,040	2,575	9,764	81%	4.48	4 @ 1	2 @ 200.0	332.0	31°	394	230	2 @ 204
IDC14-4168G	168.00	7,040	2,435	9,944	81%	4.48	4 @ 1	2 @ 200.0	332.0	31°	406	245	2 @ 204
IDC14-4180G	180.00	7,040	2,295	10,042	81%	4.74	4 @ 1	2 @ 200.0	332.0	30°	419	260	2 @ 204
IDC14-5180G	180.00	7,567	2,738	11,980	87%	5.60	5 @ 1	2 @ 250.0	415.0	32°	463	260	2 @ 214
IDC14-4192G	192.00	7,175	2,173	10,140	84%	5.00	4 @ 1	2 @ 200.0	332.0	30°	431	275	2 @ 204
IDC14-5192G	192.00	7,175	2,580	12,040	84%	5.69	5 @ 1	2 @ 250.0	415.0	32°	475	275	2 @ 214

NOTES:

1. Operation at 50 Hz will generate approximately a 17% reduction in performance.
2. Performance data based on AMCA licensed data from unheated units.
3. Maximum leaving air temperature shall not exceed 120°F.
4. Duct transition is factory mounted to air curtain and requires individual support.
5. Gas heater(s) shall not be directly connected to transition and require individual support.
6. Maximum gas supply pressure: 1/2 psi, 8 ounces, or 14 inches water column.
7. Vertically mounted indirect gas heated air curtain not available.

Berner does not recommend IDC14-1060G, IDC14-2108G and IDC14-2120G, exist only as an equivalent to competitors' models.

See sheet EP-418 for amp draws/total load requirements.

MODEL NUMBER CONFIGURATION

IDC14-1 036 G A-F-SS

Series	# of Motors	Opening Width	Heat	Voltage	Intake	Opt. Cabinet Finish
IDC14	1, 2, 3, 4, 5	036" - 192"	G=Indirect Gas Heated	*A=120/1/60 B=208/1/60 J=240/1/60 V=220/1/50 X=208/3/60 Y=240/3/60 Z=480/3/60 Q=600/3/60 O=380/3/50	F=Front	SS=Stainless Steel CC=Custom Color

*Suitable for 50hz

Sound level measured 10' (3m) from the unit in free field:
1, 2, 3, 4 & 5 motor(s): 66 dBA, 69 dBA, 71 dBA, 72 dBA & 73 dBA

Berner reserves the right to alter specifications without prior notice.



INDUSTRIAL DIRECT DRIVE 14

Positive Indirect Gas Heated Air Curtain
Electrical Performance Sheet

120/1/60 (voltage code A)											
120V MOTOR AMP DRAW = 12.6 each											
MODEL	HEATER MBH	Temp Rise °F	# CKTS	MULTIPLE CKT - MOTOR PANEL & HEATER				SINGLE CKT - MOTOR PANEL & XFMR FOR HEATER			
				AMPS PER CIRCUIT		BREAKER RATING PER CIRCUIT		# CKTS	XFMR KVA	AMPS PER CIRCUIT (including XFMR)	BREAKER RATING PER CIRCUIT
				MOTOR 120V CKT	HEATER 120V CKT	MOTOR 120V CKT	HEATER 120V CKT				
IDC14-1036G IDC14-1042G IDC14-1048G IDC14-1060G	1 @ 100	31	2	12.6	6.4	30	15	N/A	N/A	N/A	N/A
IDC14-2060G IDC14-2072G IDC14-2078G IDC14-2084G IDC14-2096G IDC14-2108G IDC14-2120G	1 @ 200	31	2	25.2	8.0	40	15	N/A	N/A	N/A	N/A
IDC14-3096G IDC14-3108G IDC14-3120G	1 @ 300	32	2	37.8	11.6	60	15	N/A	N/A	N/A	N/A
IDC14-3132G IDC14-3144G	1 @ 350	36	2	37.8	13.8	60	20	N/A	N/A	N/A	N/A
IDC14-4144G	1 @ 400	32	2	50.4	13.8	100	20	N/A	N/A	N/A	N/A
IDC14-4156G IDC14-4168G IDC14-4180G IDC14-4192G	2 @ 200	31	3	50.4	8.0/8.0	100	15/15	N/A	N/A	N/A	N/A
IDC14-5180G IDC14-5192G	2 @ 250	32	3	63.0	8.0/8.0	100	15/15	N/A	N/A	N/A	N/A



INDUSTRIAL DIRECT DRIVE 14

**Positive Indirect Gas Heated Air Curtain
Electrical Performance Sheet**

208/1/60 (voltage code B)											
208V MOTOR AMP DRAW = 6.5 each											
MULTIPLE CKT - MOTOR PANEL & HEATER								SINGLE CKT - MOTOR PANEL & XFMR FOR HEATER			
MODEL	HEATER MBH	Temp Rise °F	# CKTS	AMPS PER CIRCUIT		BREAKER RATING PER CIRCUIT		# CKTS	XFMR KVA	AMPS PER CIRCUIT (including XFMR)	BREAKER RATING PER CIRCUIT
				MOTOR 208V CKT	HEATER 120V CKT	MOTOR 208V CKT	HEATER 120V CKT				
IDC14-1036G IDC14-1042G IDC14-1048G IDC14-1060G	1 @ 100	31	2	6.5	6.4	15	15	1	1	11.3	15
IDC14-2060G IDC14-2072G IDC14-2078G IDC14-2084G IDC14-2096G IDC14-2108G IDC14-2120G	1 @ 200	31	2	13.0	8.0	20	15	1	1	17.8	25
IDC14-3096G IDC14-3108G IDC14-3120G	1 @ 300	32	2	19.5	11.6	30	15	1	2	29.1	40
IDC14-3132G IDC14-3144G	1 @ 350	36	2	19.5	13.8	30	20	1	2	29.1	40
IDC14-4144G	1 @ 400	32	2	26.0	13.8	35	20	1	2	35.6	45
IDC14-4156G IDC14-4168G IDC14-4180G IDC14-4192G	2 @ 200	31	3	26.0	8.0/8.0	35	15/15	1	2	35.6	45
IDC14-5180G IDC14-5192G	2 @ 250	32	3	32.5	8.0/8.0	45	15/15	1	2	42.1	60



INDUSTRIAL DIRECT DRIVE 14

**Positive Indirect Gas Heated Air Curtain
Electrical Performance Sheet**

				240/1/60 (voltage code J) or 220/1/50 (voltage code V)							
				240V MOTOR AMP DRAW = 6.5 each							
				MULTIPLE CKT - MOTOR PANEL & HEATER				SINGLE CKT - MOTOR PANEL & XFMR FOR HEATER			
MODEL	HEATER MBH	Temp Rise °F	# CKTS	AMPS PER CIRCUIT		BREAKER RATING PER CIRCUIT		# CKTS	XFMR KVA	AMPS PER CIRCUIT (including XFMR)	BREAKER RATING PER CIRCUIT
				MOTOR 240V CKT	HEATER 120V CKT	MOTOR 240V CKT	HEATER 120V CKT				
IDC14-1036G IDC14-1042G IDC14-1048G IDC14-1060G	1 @ 100	31	2	6.5	6.4	15	15	1	1	10.7	15
IDC14-2060G IDC14-2072G IDC14-2078G IDC14-2084G IDC14-2096G IDC14-2108G IDC14-2120G	1 @ 200	31	2	13.0	8.0	20	15	1	1	17.2	25
IDC14-3096G IDC14-3108G IDC14-3120G	1 @ 300	32	2	19.5	11.6	30	15	1	2	27.8	35
IDC14-3132G IDC14-3144G	1 @ 350	36	2	19.5	13.8	30	20	1	2	27.8	35
IDC14-4144G	1 @ 400	32	2	26.0	13.8	35	20	1	2	34.3	45
IDC14-4156G IDC14-4168G IDC14-4180G IDC14-4192G	2 @ 200	31	3	26.0	8.0/8.0	35	15/15	1	2	34.3	45
IDC14-5180G IDC14-5192G	2 @ 250	32	3	32.5	8.0/8.0	45	15/15	1	2	40.8	60



INDUSTRIAL DIRECT DRIVE 14

**Positive Indirect Gas Heated Air Curtain
Electrical Performance Sheet**

208/3/60 (voltage code X)											
208V MOTOR AMP DRAW = 6.5 each											
MULTIPLE CKT - MOTOR PANEL & HEATER								SINGLE CKT - MOTOR PANEL & XFMR FOR HEATER			
MODEL	HEATER MBH	Temp Rise °F	# CKTS	AMPS PER CIRCUIT		BREAKER RATING PER CIRCUIT		# CKTS	XFMR KVA	AMPS PER CIRCUIT (including XFMR)	BREAKER RATING PER CIRCUIT
				MOTOR 208V CKT	HEATER 120V CKT	MOTOR 208V CKT	HEATER 120V CKT				
IDC14-1036G IDC14-1042G IDC14-1048G IDC14-1060G	1 @ 100	31	2	6.5	6.4	15	15	1	1	11.3	15
IDC14-2060G IDC14-2072G IDC14-2078G IDC14-2084G IDC14-2096G IDC14-2108G IDC14-2120G	1 @ 200	31	2	13.0	8.0	20	15	1	1	17.8	25
IDC14-3096G IDC14-3108G IDC14-3120G	1 @ 300	32	2	19.5	11.6	30	15	1	2	29.1	40
IDC14-3132G IDC14-3144G	1 @ 350	36	2	19.5	13.8	30	20	1	2	29.1	40
IDC14-4144G	1 @ 400	32	2	26.0	13.8	35	20	1	2	35.6	45
IDC14-4156G IDC14-4168G IDC14-4180G IDC14-4192G	2 @ 200	31	3	26.0	8.0/8.0	35	15/15	1	2	35.6	45
IDC14-5180G IDC14-5192G	2 @ 250	32	3	32.5	8.0/8.0	45	15/15	1	2	42.1	60



INDUSTRIAL DIRECT DRIVE 14

Positive Indirect Gas Heated Air Curtain
Electrical Performance Sheet

240/3/60 (voltage code Y)											
240V MOTOR AMP DRAW = 6.5 each											
MULTIPLE CKT - MOTOR PANEL & HEATER								SINGLE CKT - MOTOR PANEL & XFMR FOR HEATER			
MODEL	HEATER MBH	Temp Rise °F	# CKTS	AMPS PER CIRCUIT		BREAKER RATING PER CIRCUIT		# CKTS	XFMR KVA	AMPS PER CIRCUIT (including XFMR)	BREAKER RATING PER CIRCUIT
				MOTOR 240V CKT	HEATER 120V CKT	MOTOR 240V CKT	HEATER 120V CKT				
IDC14-1036G IDC14-1042G IDC14-1048G IDC14-1060G	1 @ 100	31	2	6.5	6.4	15	15	1	1	10.7	15
IDC14-2060G IDC14-2072G IDC14-2078G IDC14-2084G IDC14-2096G IDC14-2108G IDC14-2120G	1 @ 200	31	2	13.0	8.0	20	15	1	1	17.2	25
IDC14-3096G IDC14-3108G IDC14-3120G	1 @ 300	32	2	19.5	11.6	30	15	1	2	27.8	35
IDC14-3132G IDC14-3144G	1 @ 350	36	2	19.5	13.8	30	20	1	2	27.8	35
IDC14-4144G	1 @ 400	32	2	26.0	13.8	35	20	1	2	34.3	45
IDC14-4156G IDC14-4168G IDC14-4180G IDC14-4192G	2 @ 200	31	3	26.0	8.0/8.0	35	15/15	1	2	34.3	45
IDC14-5180G IDC14-5192G	2 @ 250	32	3	32.5	8.0/8.0	45	15/15	1	2	40.8	60

Berner reserves the right to alter specifications without prior notice.



INDUSTRIAL DIRECT DRIVE 14

**Positive Indirect Gas Heated Air Curtain
Electrical Performance Sheet**

480/3/60 (voltage code Z)											
480V MOTOR AMP DRAW = 3.2 each											
MODEL	HEATER MBH	Temp Rise °F	# CKTS	MULTIPLE CKT - MOTOR PANEL & HEATER				SINGLE CKT - MOTOR PANEL & XFMR FOR HEATER			
				AMPS PER CIRCUIT		BREAKER RATING PER CIRCUIT		# CKTS	XFMR KVA	AMPS PER CIRCUIT (including XFMR)	BREAKER RATING PER CIRCUIT
				MOTOR 480V CKT	HEATER 120V CKT	MOTOR 480V CKT	HEATER 120V CKT				
IDC14-1036G IDC14-1042G IDC14-1048G IDC14-1060G	1 @ 100	31	2	3.2	6.4	15	15	1	1	5.3	15
IDC14-2060G IDC14-2072G IDC14-2078G IDC14-2084G IDC14-2096G IDC14-2108G IDC14-2120G	1 @ 200	31	2	6.4	8.0	15	15	1	1	8.5	15
IDC14-3096G IDC14-3108G IDC14-3120G	1 @ 300	32	2	9.6	11.6	15	15	1	2	13.8	20
IDC14-3132G IDC14-3144G	1 @ 350	36	2	9.6	13.8	15	20	1	2	13.8	20
IDC14-4144G	1 @ 400	32	2	12.8	13.8	20	20	1	2	17.0	25
IDC14-4156G IDC14-4168G IDC14-4180G IDC14-4192G	2 @ 200	31	3	12.8	8.0/8.0	20	15/15	1	2	17.0	25
IDC14-5180G IDC14-5192G	2 @ 250	32	3	16.0	8.0/8.0	20	15/15	1	2	20.2	30



INDUSTRIAL DIRECT DRIVE 14

**Positive Indirect Gas Heated Air Curtain
Electrical Performance Sheet**

600/3/60 (voltage code Q)											
600V MOTOR AMP DRAW = 2.0 each											
MODEL	HEATER MBH	Temp Rise °F	# CKTS	MULTIPLE CKT - MOTOR PANEL & HEATER				SINGLE CKT - MOTOR PANEL & XFMR FOR HEATER			
				AMPS PER CIRCUIT		BREAKER RATING PER CIRCUIT		# CKTS	XFMR KVA	AMPS PER CIRCUIT (including XFMR)	BREAKER RATING PER CIRCUIT
				MOTOR 600V CKT	HEATER 120V CKT	MOTOR 600V CKT	HEATER 120V CKT				
IDC14-1036G IDC14-1042G IDC14-1048G IDC14-1060G	1 @ 100	31	2	2.0	6.4	15	15	1	1	3.7	15
IDC14-2060G IDC14-2072G IDC14-2078G IDC14-2084G IDC14-2096G IDC14-2108G IDC14-2120G	1 @ 200	31	2	4.0	8.0	15	15	1	1	5.7	15
IDC14-3096G IDC14-3108G IDC14-3120G	1 @ 300	32	2	6.0	11.6	15	15	1	2	9.3	15
IDC14-3132G IDC14-3144G	1 @ 350	36	2	6.0	13.8	15	20	1	2	9.3	15
IDC14-4144G	1 @ 400	32	2	8.0	13.8	15	20	1	2	11.3	15
IDC14-4156G IDC14-4168G IDC14-4180G IDC14-4192G	2 @ 200	31	3	8.0	8.0/8.0	15	15/15	1	2	11.3	15
IDC14-5180G IDC14-5192G	2 @ 250	32	3	10.0	8.0/8.0	15	15/15	1	2	13.3	20

Berner reserves the right to alter specifications without prior notice.



INDUSTRIAL DIRECT DRIVE 14

**Positive Indirect Gas Heated Air Curtain
Electrical Performance Sheet**

380/3/50 (voltage code O)											
380V MOTOR AMP DRAW = 6.5 each											
MULTIPLE CKT - MOTOR PANEL & HEATER								SINGLE CKT - MOTOR PANEL & XFMR FOR HEATER			
MODEL	HEATER MBH	Temp Rise °F	# CKTS	AMPS PER CIRCUIT		BREAKER RATING PER CIRCUIT		# CKTS	XFMR KVA	AMPS PER CIRCUIT (including XFMR)	BREAKER RATING PER CIRCUIT
				MOTOR 380V CKT	HEATER 120V CKT	MOTOR 380V CKT	HEATER 120V CKT				
IDC14-1036G IDC14-1042G IDC14-1048G IDC14-1060G	1 @ 100	31	2	6.5	6.4	15	15	1	1	11.0	15
IDC14-2060G IDC14-2072G IDC14-2078G IDC14-2084G IDC14-2096G IDC14-2108G IDC14-2120G	1 @ 200	31	2	13.0	8.0	20	15	1	1	17.5	25
IDC14-3096G IDC14-3108G IDC14-3120G	1 @ 300	32	2	19.5	11.6	30	15	1	2	28.6	40
IDC14-3132G IDC14-3144G	1 @ 350	36	2	19.5	13.8	30	20	1	2	28.6	40
IDC14-4144G	1 @ 400	32	2	26.0	13.8	35	20	1	2	35.1	45
IDC14-4156G IDC14-4168G IDC14-4180G IDC14-4192G	2 @ 200	31	3	26.0	8.0/8.0	35	15/15	1	2	35.1	45
IDC14-5180G IDC14-5192G	2 @ 250	32	3	32.5	8.0/8.0	45	15/15	1	2	41.6	60

IDC14 INDIRECT GAS HEATED ONE HEATER SYSTEM

- NOTES:**
- 1 AIR CURTAIN MUST BE INSTALLED SO AIR STREAM IS NOT OBSTRUCTED WHEN DEFLECTED 20° TO EITHER SIDE OF \bar{c} .
 - 2 ELECTRICAL CONNECTIONS TO BE FLEXIBLE.
 - 3 FIELD VERIFY DIMENSIONS.
 - 4 ANCHORS TO SUPPORTING STRUCTURE BY OTHERS.
 - 5 ADEQUACY OF SUPPORTING STRUCTURE IS TO BE VERIFIED BY A PROFESSIONAL STRUCTURAL ENGINEER.
 - 6 LETTER "G" IN MODEL NUMBER DESIGNATES, POSITIVE INDIRECT GAS HEATER UNIT.
 - 7 STANDARD CONTROL PANEL LEFT HAND MOUNT, OPTIONAL RIGHT HAND MOUNT, OR REMOTE. PLEASE SPECIFY.
 - 8 XF SERIES FURNACES ONLY HAVE TWO MOUNTING POINTS.
 - 9 SUPPLY PRESSURES HIGHER THAN 0.50 POUND REQUIRE INSTALLATION OF AN ADDITIONAL SERVICE REGULATOR EXTERNAL TO THE UNIT.
 - 10 DIMENSIONS IN INCHES [CENTIMETERS].

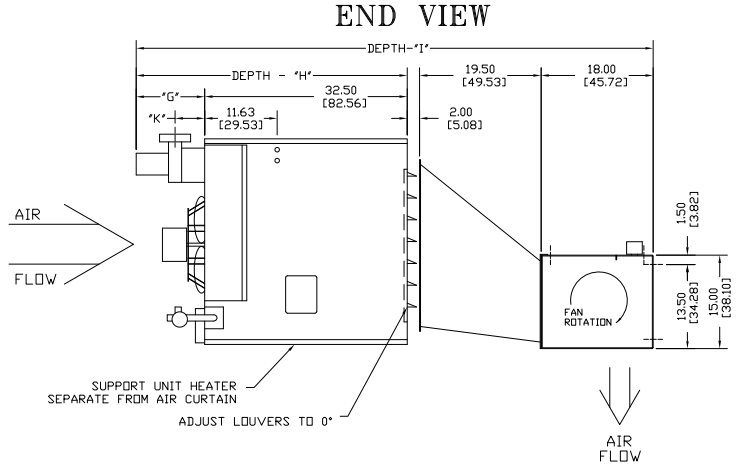
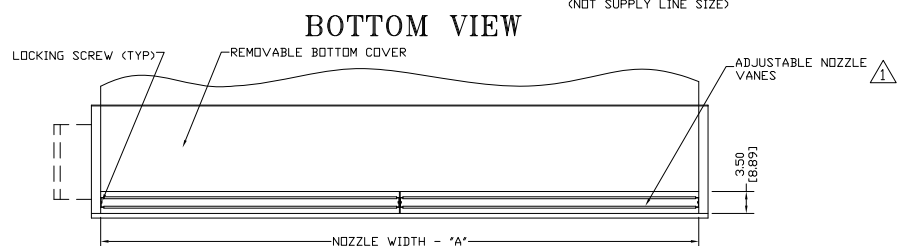
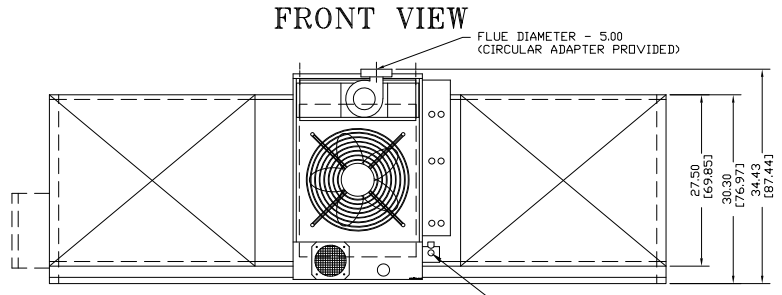
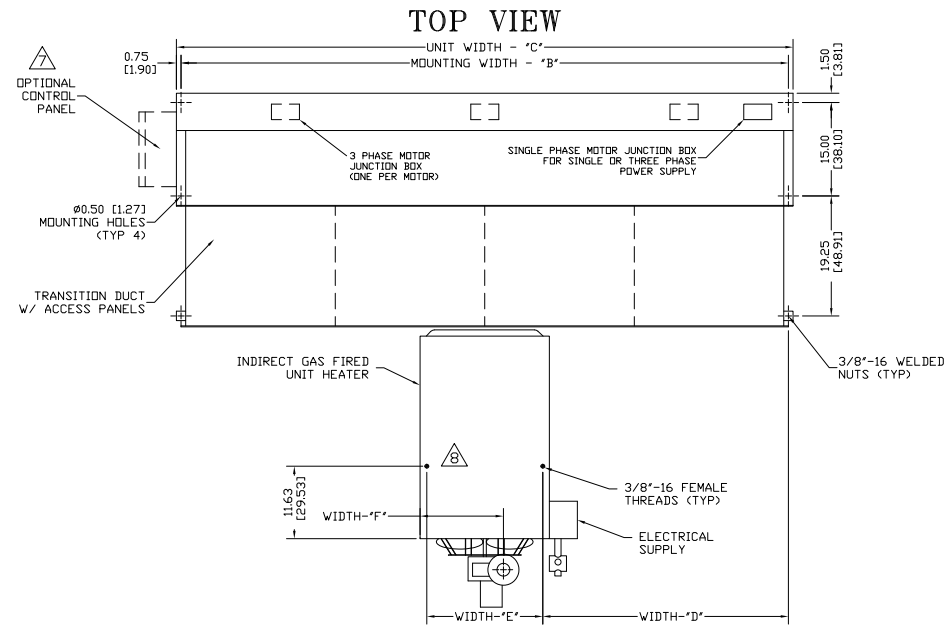

CAUTION:
HEATER IS EQUIPPED FOR A MAXIMUM GAS SUPPLY PRESSURE OF 1/2 POUND, 8 DUNCES, OR 14 INCHES WATER COLUMN.

MODEL	NOZZLE WIDTH "A"	MOUNTING WIDTH "B"	UNIT WIDTH "C"	TOTAL NO. HEATER(S) @ MBTU	WIDTH "D"	HEATER MOUNTING WIDTH "E"	WIDTH "F"	DEPTH "G"	DEPTH "H"	DEPTH "I"	FLUE "J"	DEPTH "K"	WIDTH "L"	PROJECT	LOCATION	ARCHITECT	ENGINEER	REV.	A
														DWG. NO.	DATE	BY	REPLACES	BY	TITLE:
IDC14-1036G	36.0 [91.44]	37.50 [95.25]	39.0 [99.06]	1 @ 100	9.44 [23.98]	18.63 [47.32]	13.38 [33.98]	11.00 [27.94]	43.50 [110.50]	83.0 [210.82]	5.0 [12.70]	4.75 [12.06]	-						
IDC14-1042G	42.0 [106.68]	43.50 [110.49]	45.0 [114.30]	1 @ 100	12.44 [31.98]	18.63 [47.32]	13.38 [33.98]	11.00 [27.94]	43.50 [110.50]	83.0 [210.82]	5.0 [12.70]	4.75 [12.06]	-						
IDC14-1048G	48.0 [121.92]	49.50 [125.73]	51.0 [129.54]	1 @ 100	15.44 [39.23]	18.63 [47.32]	13.38 [33.98]	11.00 [27.94]	43.50 [110.50]	83.0 [210.82]	5.0 [12.70]	4.75 [12.06]	-						
IDC14-1060G	66.0 [167.64]	67.50 [171.45]	69.0 [175.26]	1 @ 100	24.44 [61.98]	18.63 [47.32]	13.38 [33.98]	11.00 [27.94]	43.50 [110.50]	83.0 [210.82]	5.0 [12.70]	4.75 [12.06]	-						
IDC14-2060G	66.0 [167.64]	67.50 [171.45]	69.0 [175.26]	1 @ 200	18.44 [46.84]	30.63 [77.80]	19.38 [49.23]	11.00 [27.94]	43.50 [110.50]	83.0 [210.82]	5.0 [12.70]	4.75 [12.06]	-						
IDC14-2072G	72.0 [182.88]	73.50 [186.69]	75.0 [190.50]	1 @ 200	21.44 [54.46]	30.63 [77.80]	19.38 [49.23]	11.00 [27.94]	43.50 [110.50]	83.0 [210.82]	5.0 [12.70]	4.75 [12.06]	-						
														DWG. NO.	IDC14-IGF1-XF	TITLE:	BERNER		
														DATE	15SEP2020	MODEL IDC14 AIR CURTAIN			
														BY	S. Beil	INDIRECT GAS FIRED - ONE HEATER SYSTEM			
														REPLACES	30DEC2019				
														BY	A.Johnston	BERNER INTERNATIONAL CORP. NEW CASTLE, PA.			

IDC 14 INDIRECT GAS HEATED ONE HEATER SYSTEM

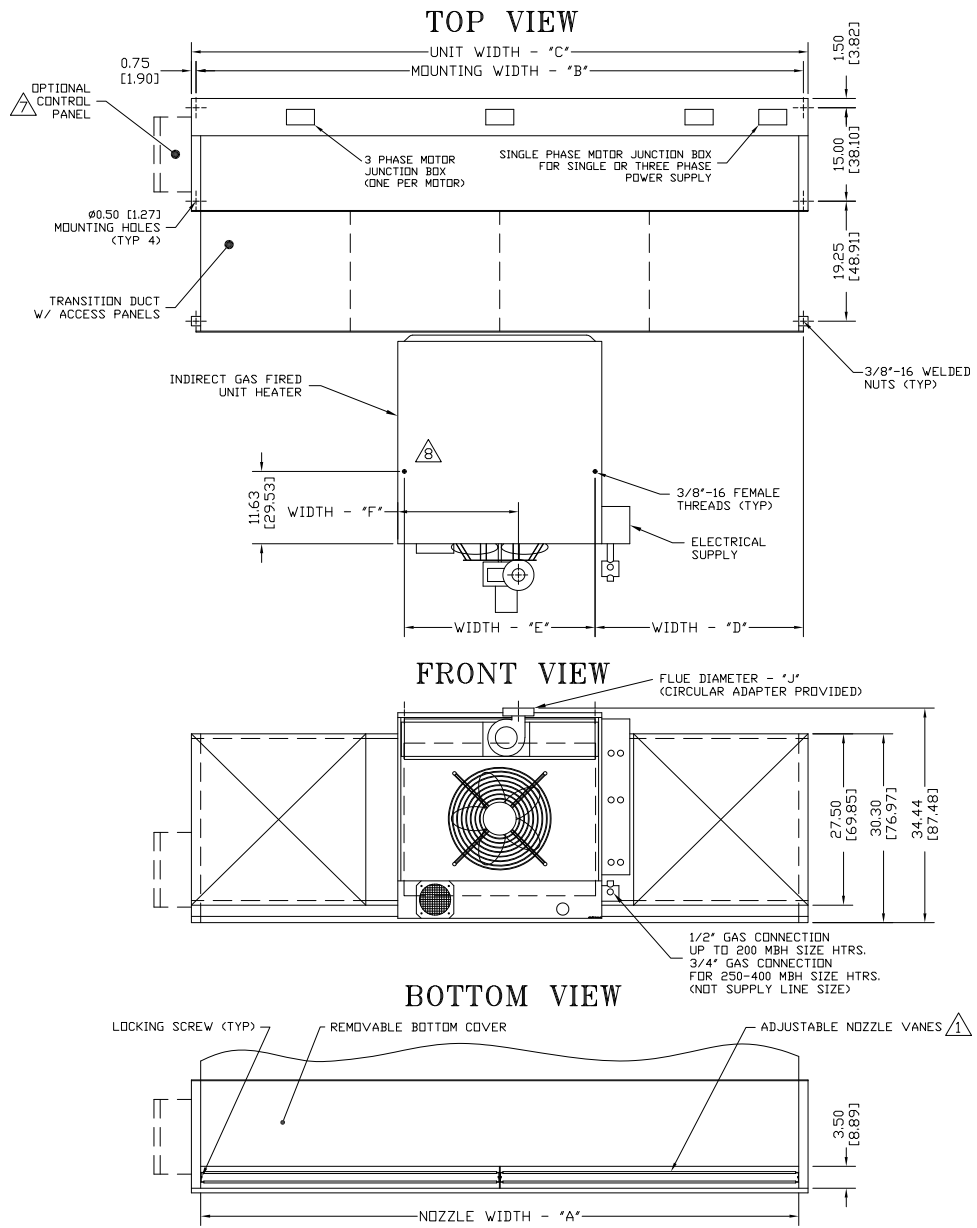

NOTES:

- 1 AIR CURTAIN MUST BE INSTALLED SO AIR STREAM IS NOT OBSTRUCTED WHEN DEFLECTED 20° TO EITHER SIDE OF \bar{C} .
- 2 ELECTRICAL CONNECTIONS TO BE FLEXIBLE.
- 3 FIELD VERIFY DIMENSIONS.
- 4 ANCHORS TO SUPPORTING STRUCTURE BY OTHERS.
- 5 ADEQUACY OF SUPPORTING STRUCTURE IS TO BE VERIFIED BY A PROFESSIONAL STRUCTURAL ENGINEER.
- 6 LETTER "G" IN MODEL NUMBER DESIGNATES POSITIVE INDIRECT GAS HEATER UNIT.
- 7 STANDARD CONTROL PANEL LEFT HAND MOUNT, OPTIONAL RIGHT HAND MOUNT, OR REMOTE. PLEASE SPECIFY.
- 8 XF SERIES FURNACES ONLY HAVE TWO MOUNTING POINTS.
- 9 SUPPLY PRESSURES HIGHER THAN 0.50 POUND REQUIRE INSTALLATION OF AN ADDITIONAL SERVICE REGULATOR EXTERNAL TO THE UNIT.
- 10 DIMENSIONS IN INCHES [CENTIMETERS].

END VIEW

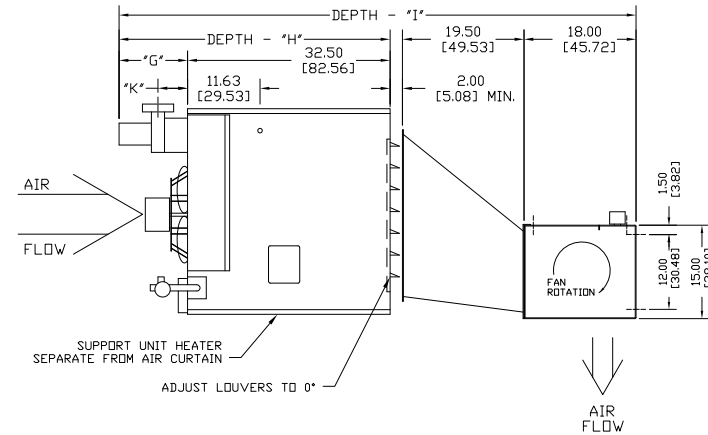

CAUTION:

HEATER IS EQUIPPED FOR A MAXIMUM GAS SUPPLY PRESSURE OF 1/2 POUND, 8 DUNCES, OR 14 INCHES WATER COLUMN.

MODEL	NOZZLE WIDTH "A"	MOUNTING WIDTH "B"	UNIT WIDTH "C"	TOTAL NO. HEATER(S) @ MBTU	WIDTH "D"	HEATER MOUNTING WIDTH "E"	WIDTH "F"	DEPTH "G"	DEPTH "H"	DEPTH "I"	FLUE "J"	DEPTH "K"	WIDTH "L"	PROJECT	LOCATION	ARCHITECT	ENGINEER	REV.	A
														DWG. NO.	DATE	BY	REPLACES	BY	TITLE:
IDC14-2078G	78.0 [198.12]	79.50 [201.93]	81.0 [205.74]	1 @ 200	24.44 [62.08]	30.63 [77.80]	19.38 [49.22]	11.00 [27.94]	43.50 [110.50]	83.00 [210.82]	5.0 [12.70]	4.75 [12.06]	-						
IDC14-2084G	84.0 [213.36]	85.50 [217.17]	87.0 [220.98]	1 @ 200	27.44 [69.70]	30.63 [77.80]	19.38 [49.22]	11.00 [27.94]	43.50 [110.50]	83.00 [210.82]	5.0 [12.70]	4.75 [12.06]	-	DWG. NO.	IDC14-IGF2-XF				
IDC14-2096G	99.0 [251.46]	100.50 [255.27]	102.0 [259.08]	1 @ 200	34.94 [88.75]	30.63 [77.80]	19.38 [49.22]	11.00 [27.94]	43.50 [110.50]	83.00 [210.82]	5.0 [12.70]	4.75 [12.06]	-	DATE	15SEP2020				
IDC14-3096G	99.0 [251.46]	100.50 [255.27]	102.0 [259.08]	1 @ 300	25.94 [65.88]	48.63 [123.52]	28.38 [72.08]	12.25 [31.12]	44.75 [113.66]	84.25 [213.99]	6.0 [15.24]	5.13 [13.02]	-	BY	S. Beil				
IDC14-2108G	108.0 [274.32]	109.50 [278.13]	111.0 [281.94]	1 @ 200	39.44 [100.18]	30.63 [77.80]	19.38 [49.22]	11.00 [27.94]	43.50 [110.50]	83.00 [210.82]	5.0 [12.70]	4.75 [12.06]	-	REPLACES	31DEC2019				
IDC14-3108G	108.0 [274.32]	109.50 [278.13]	111.0 [281.94]	1 @ 300	30.44 [77.32]	48.63 [123.52]	28.38 [72.08]	12.25 [31.12]	44.75 [113.66]	84.25 [213.99]	6.0 [15.24]	5.13 [13.02]	-	BY	A. Johnston				
														TITLE:		BERNER			
																MODEL IDC14 AIR CURTAIN INDIRECT GAS FIRED - ONE HEATER SYSTEM			
																BERNER INTERNATIONAL CORP. NEW CASTLE, PA.			

IDC14 INDIRECT GAS HEATED ONE HEATER SYSTEM

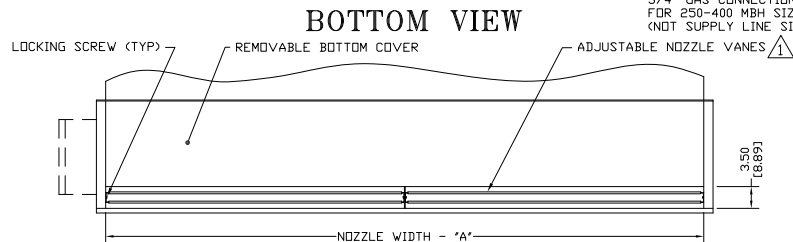
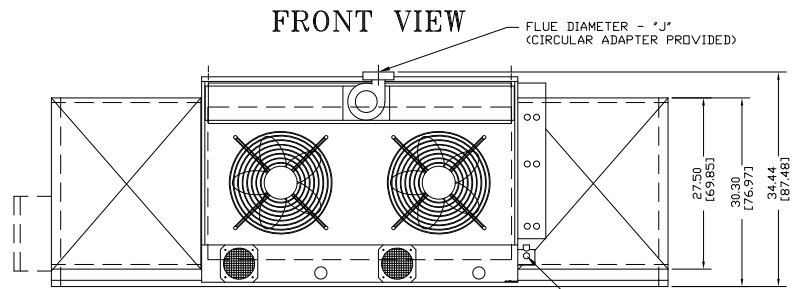
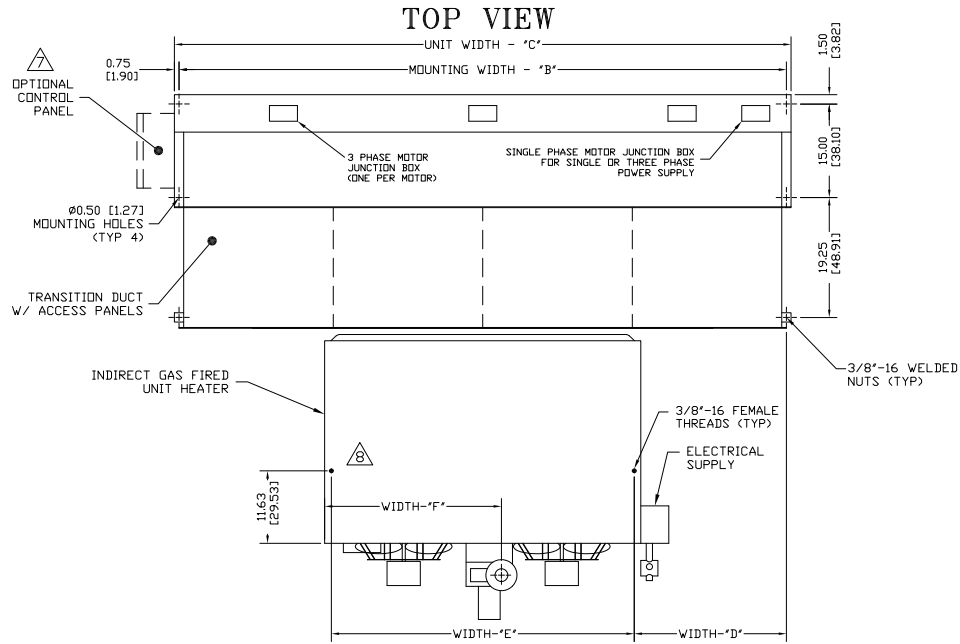

NOTES:

- ⚠️ AIR CURTAIN MUST BE INSTALLED SO AIR STREAM IS NOT OBSTRUCTED WHEN DEFLECTED 20° TO EITHER SIDE OF ϕ .
- ⚠️ ELECTRICAL CONNECTIONS TO BE FLEXIBLE.
- ⚠️ FIELD VERIFY DIMENSIONS.
- ⚠️ ANCHORS TO SUPPORTING STRUCTURE BY OTHERS.
- ⚠️ ADEQUACY OF SUPPORTING STRUCTURE IS TO BE VERIFIED BY A PROFESSIONAL STRUCTURAL ENGINEER.
- ⚠️ LETTER "G" IN MODEL NUMBER DESIGNATES POSITIVE INDIRECT GAS HEATER UNIT.
- ⚠️ STANDARD CONTROL PANEL LEFT HAND MOUNT, OPTIONAL RIGHT HAND MOUNT, OR REMOTE. PLEASE SPECIFY.
- ⚠️ XF SERIES FURNACES ONLY HAVE TWO MOUNTING POINTS.
- ⚠️ SUPPLY PRESSURES HIGHER THAN 0.50 POUND REQUIRE INSTALLATION OF AN ADDITIONAL SERVICE REGULATOR EXTERNAL TO THE UNIT.
- ⚠️ DIMENSIONS IN INCHES (CENTIMETERS).

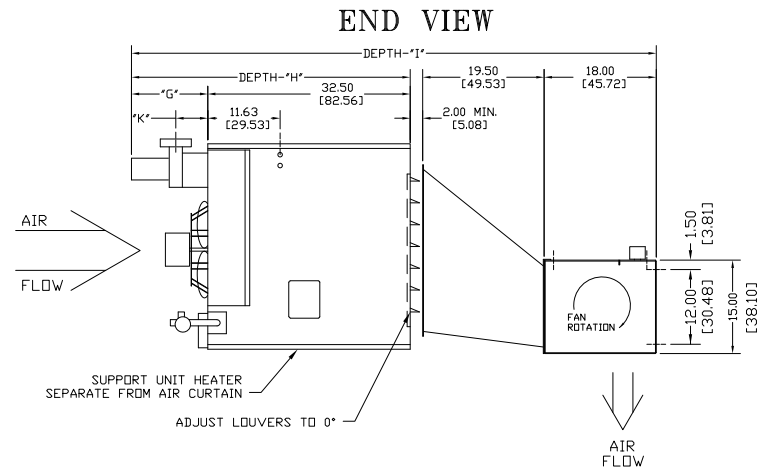

CAUTION:

HEATER IS EQUIPPED FOR A MAXIMUM GAS SUPPLY PRESSURE OF 1/2 POUND, 8 OUNCES, OR 14 INCHES WATER COLUMN.

MODEL	NOZZLE WIDTH "A"	MOUNTING WIDTH "B"	UNIT WIDTH "C"	TOTAL NO. HEATER(S) @ MBTU	WIDTH "D"	HEATER MOUNTING WIDTH "E"	WIDTH "F"	DEPTH "G"	DEPTH "H"	DEPTH "I"	FLUE "J"	DEPTH "K"	WIDTH "L"	PROJECT	LOCATION	ARCHITECT	ENGINEER	REV.
IDC14-2120G	117.0 [297.18]	118.50 [300.99]	120.0 [304.80]	1 @ 200	43.94 [111.61]	30.63 [77.80]	19.38 [49.22]	11.00 [27.94]	43.50 [110.50]	83.00 [210.82]	5.0 [12.70]	4.75 [12.06]	-					
IDC14-3120G	117.0 [297.18]	118.50 [300.99]	120.0 [304.80]	1 @ 300	34.94 [87.48]	48.63 [123.52]	28.38 [72.08]	12.25 [31.12]	44.75 [113.66]	84.25 [213.99]	6.0 [15.24]	5.13 [13.02]	-	DWG. NO.	IDC14-IGF3-XF	TITLE:	BERNER	
IDC14-3132G	132.0 [335.28]	133.50 [339.09]	135.0 [342.90]	1 @ 350	42.44 [107.80]	48.63 [123.52]	28.38 [72.08]	12.25 [31.12]	44.75 [113.66]	84.25 [213.99]	6.0 [15.24]	5.13 [13.02]	-	DATE	15SEP2020		MODEL IDC14 AIR CURTAIN	
IDC14-3144G	144.0 [365.76]	145.50 [369.57]	147.0 [373.38]	1 @ 350	48.44 [123.04]	48.63 [123.52]	28.38 [72.08]	12.25 [31.12]	44.75 [113.66]	84.25 [213.99]	6.0 [15.24]	5.13 [13.02]	-	BY	S. Beil		INDIRECT GAS FIRED - ONE HEATER SYSTEM	
IDC14-4144G	144.0 [365.76]	145.50 [369.57]	147.0 [373.38]	1 @ 400	48.44 [123.04]	48.63 [123.52]	28.38 [72.08]	12.25 [31.12]	44.75 [113.66]	84.25 [213.99]	6.0 [15.24]	5.13 [13.02]	-	REPLACES	02JAN2020		BERNER INTERNATIONAL CORP.	
														BY	A.Johnston		NEW CASTLE, PA.	

IDC14 INDIRECT GAS HEATED TWO HEATER SYSTEM

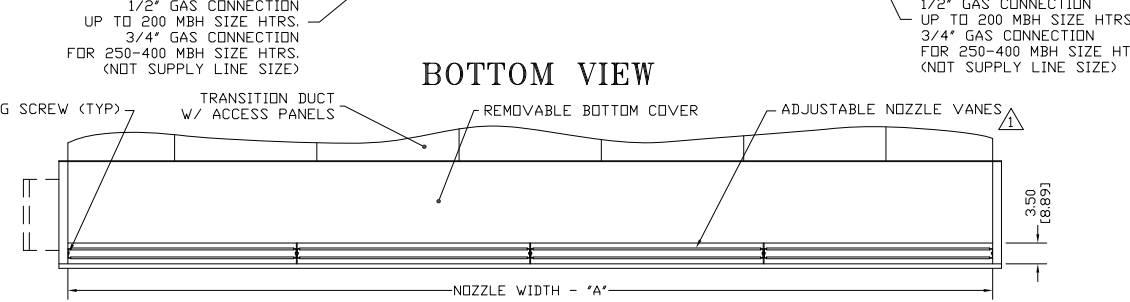
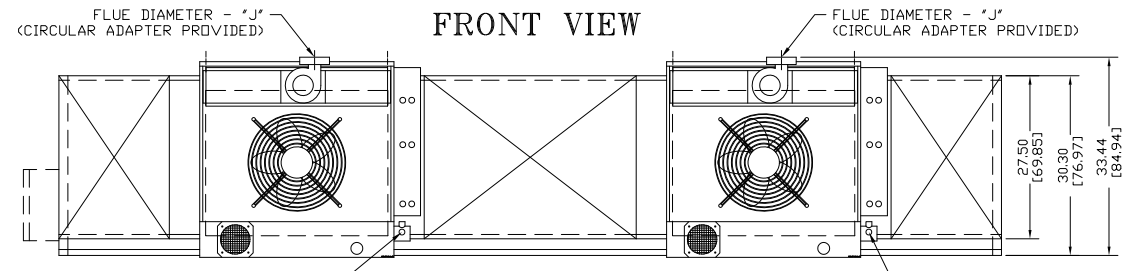
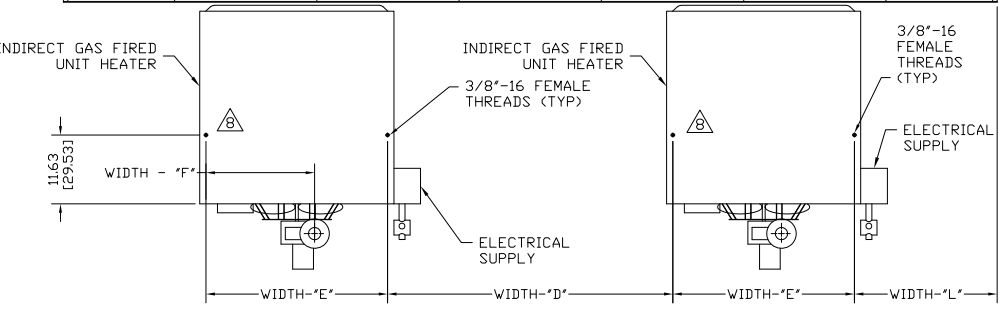
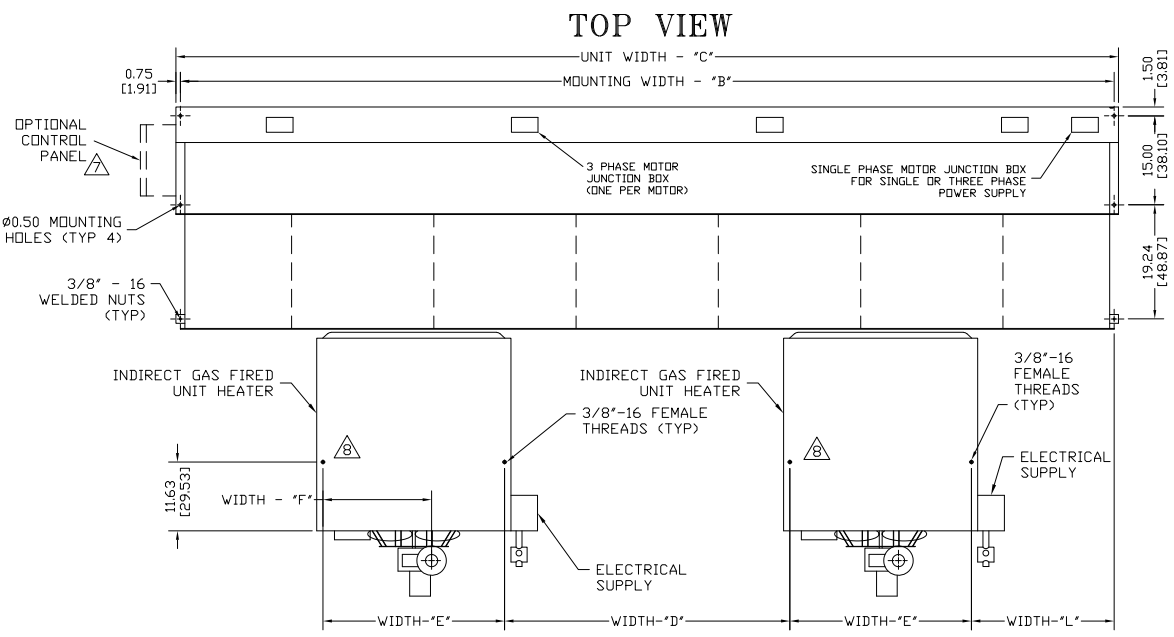

NOTES:

- 1 AIR CURTAIN MUST BE INSTALLED SO AIR STREAM IS NOT OBSTRUCTED WHEN DEFLECTED 20° TO EITHER SIDE OF \bar{C} .
- 2 ELECTRICAL CONNECTIONS TO BE FLEXIBLE.
- 3 FIELD VERIFY DIMENSIONS.
- 4 ANCHORS TO SUPPORTING STRUCTURE BY OTHERS.
- 5 ADEQUACY OF SUPPORTING STRUCTURE IS TO BE VERIFIED BY A PROFESSIONAL STRUCTURAL ENGINEER.
- 6 LETTER "G" IN MODEL NUMBER DESIGNATES POSITIVE INDIRECT GAS HEATER UNIT.
- 7 STANDARD CONTROL PANEL LEFT HAND MOUNT, OPTIONAL RIGHT HAND MOUNT, OR REMOTE. PLEASE SPECIFY.
- 8 XF SERIES FURNACES ONLY HAVE TWO MOUNTING POINTS.
- 9 SUPPLY PRESSURES HIGHER THAN 0.50 POUND REQUIRE INSTALLATION OF AN ADDITIONAL SERVICE REGULATOR EXTERNAL TO THE UNIT.
- 10 DIMENSIONS IN INCHES (CENTIMETERS).

CAUTION:
HEATER IS EQUIPPED FOR A MAXIMUM GAS SUPPLY PRESSURE OF 1/2 POUND, 8 OUNCES, OR 14 INCHES WATER COLUMN.

MODEL	NOZZLE WIDTH "A"	MOUNTING WIDTH "B"	UNIT WIDTH "C"	TOTAL NO. HEATER(S) @ MBTU	WIDTH "D"	HEATER MOUNTING WIDTH "E"	WIDTH "F"	DEPTH "G"	DEPTH "H"	DEPTH "I"	FLUE "J"	DEPTH "K"	WIDTH "L"	PROJECT	LOCATION	ARCHITECT	ENGINEER	REV.	
IDC14-4156G	156.0 [396.24]	157.50 [400.05]	159.0 [403.86]	2 @ 200	48.13 [122.25]	30.63 [77.80]	19.38 [49.22]	11.00 [27.94]	43.50 [110.50]	83.00 [210.82]	5.0 [12.70]	4.75 [12.06]	24.06 [61.11]						
IDC14-4168G	168.0 [426.72]	169.50 [430.53]	171.0 [434.34]	2 @ 200	54.13 [137.49]	30.63 [77.80]	19.38 [49.22]	11.00 [27.94]	43.50 [110.50]	83.00 [210.82]	5.0 [12.70]	4.75 [12.06]	27.06 [68.73]	DWG. NO.	IDC14-1GF4-XF	TITLE:	BERNER		
IDC14-4180G	180.0 [457.20]	181.50 [461.01]	183.0 [464.82]	2 @ 200	60.13 [152.73]	30.63 [77.80]	19.38 [49.22]	11.00 [27.94]	43.50 [110.50]	83.00 [210.82]	5.0 [12.70]	4.75 [12.06]	30.06 [76.35]	DATE	15SEP2020	BY	S. BEIL	MODEL IDC14 AIR CURTAIN INDIRECT GAS FIRED - TWO HEATER SYSTEM	
IDC14-4180G	180.0 [457.20]	181.50 [461.01]	183.0 [464.82]	2 @ 250	60.13 [152.73]	30.63 [77.80]	19.38 [49.22]	11.00 [27.94]	43.50 [110.50]	83.00 [210.82]	5.0 [12.70]	4.75 [12.06]	30.06 [76.35]	REPLACES	02JAN2020	BY	A. Johnston	BERNER INTERNATIONAL CORP. NEW CASTLE, PA.	
IDC14-4192G	192.0 [487.68]	193.50 [491.49]	195.0 [495.30]	2 @ 200	66.13 [167.97]	30.63 [77.80]	19.38 [49.22]	11.00 [27.94]	43.50 [110.50]	83.00 [210.82]	5.0 [12.70]	4.75 [12.06]	33.06 [83.97]						
IDC14-5192G	192.0 [487.68]	193.50 [491.49]	195.0 [495.30]	2 @ 250	66.13 [167.97]	30.63 [77.80]	19.38 [49.22]	11.00 [27.94]	43.50 [110.50]	83.00 [210.82]	5.0 [12.70]	4.75 [12.06]	33.06 [83.97]						